



K424 TRADITIONAL - LED ACORN

The K424 Traditional Acorn offers an updated version of the traditional globe with efficient optical performance, careful engineering and incredibly easy maintenance characteristics, without compromising the historical authenticity of the product's appearance.

PROJECT: _____

PREPARED BY: _____

DATE: _____

PRODUCT SPECIFICATIONS

LED ENGINE

The light engine shall be an array of 4 or 6 Cree Chip On Board (COB) diodes mounted to a highly conductive aluminum extrusion with the use of 2 electrical connectors. The aluminum extrusion will be mechanically attached to a thermal heat sink at both the top and the bottom of the aluminum extrusion. It shall remain in thermal contact to the heat sinks with the use of conductive silicone. There will be an aluminum up-light reflector available in Type III or Type V IESNA distribution patterns.

REFRACTIVE GLOBE

The prismatic refractor shall be made of injection moulded acrylic or polycarbonate and produce Type III or Type V IESNA distribution patterns. It shall maintain a minimum thickness of 1/4".

The acrylic globe is secured to the luminaire body by means of a split-clamping ring of durable cast A319 aluminum, which allows easy, tool-less removal of the globe assembly from the luminaire body by means of King Luminaire's Rotolock™ system.

A minimum ingress protection against water or dust particles of IP66 for the LED optical chamber is provided by non-porous, closed-cell silicon rubber sponge gasketing which is highly efficient in sealing against particle ingress for a wide temperature range (-40°F to 310°F).

LUMINAIRE CONSTRUCTION

All K424 Traditional Acorn cast components shall consist of a heavy grade A319 cast aluminum. The main body, or capital, acts as an enclosure for the driver assembly and is of adequate thickness to give sufficient structural rigidity. The capital shall have an opening at the base tenon body to allow the luminaire to be mounted to a tenon of 3-1/2" maximum diameter. The luminaire shall be locked in place by means of heavy duty, stainless steel set-screws.

DRIVER

CSA certified and/or UL listed, electronic programmable, constant light output (CLO) driver with a

0-10v dimming lead. Driver shall supply correct DC voltage and current to maintain proper operation of the emitters. The driver shall be UL1310/UL48 Class 1 certified, and contain over-circuit, over-voltage, and over-power protection. An in-line ferrite choke is utilized to provide protection against EFT's. The multi-volt driver shall be capable to connect to AC input voltages of 120V - 277V or 347 - 480V. The driver shall have a minimum life expectancy of 100,000 hrs with a case temperature range of -40°C to a maximum of 60°C. The driver casing shall have a minimum ingress protection rating of IP67.

PHOTOMETRICS

Fixtures are tested to IESNA LM79 specifications. These reports are available upon request.

CHROMATICITY

High output COB LEDs come standard at 3000K & 4000K (+/- 300K) with a minimum nominal 70 CRI. Additional CCT emitters are available upon request.

LUMEN MAINTENANCE

Reported (TM21) and Calculated (L70) reports are available upon request with a minimum calculated value of 100,000 hrs.

WIRING

All internal wiring and connections shall be completed so that it will be necessary only to attach the incoming supply connectors to Mate-N-Lok connectors or to a terminal block. Mate-N-Lok shall be certified for 600V operation. Internal wire connectors shall be crimp connector only and rated at 1000V and 150°C. All wiring to be CSA certified and/or UL listed, type SFF-2, SEWF-2, or SEW-2 No. 14 gauge, 150°C, 600V, and color coded for the required voltage.

THERMALS

Fixtures tested to determine the maximum in-situ case temperature of the LED emitters as recommended by Cree. This report is available upon request.

FINISH

Housing is finished with a 13 step Kingcoat™ SuperDurable polyester

TGIC powder coat. Standard colors include strobe white, brown metal, marina blue, gate gray, Chicago bronze, standard gold, standard black, federal green and rain forest. Please see our website for a complete list of colors. Additional RAL or custom color matches are available.

MISCELLANEOUS

All exterior hardware and fasteners, wholly or partly exposed, shall be stainless steel alloy. All internal fasteners are stainless steel or zinc coated steel. All remaining internal hardware is stainless steel, aluminum alloy, or zinc coated steel.

WARRANTY

The K424 Traditional Acorn LED luminaire comes with a 7 year limited warranty.

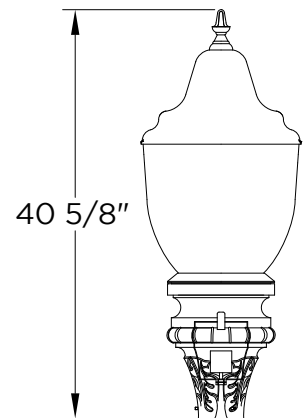

CERTIFICATION:

CSA US Listed
Suitable for wet locations
ISO 9001
IP66
ARRA Compliant
LM79 / LM80 Compliant

DRIVER INFO:

>0.9 Power Factor
<20% Total Harmonic Distortion
120 - 277V & 347 - 480V
-40°C Min. Case Temperature
60°C Max. Case Temperature
Surge Protection: ANSI C136.2
extreme level 20kV/10kA

EPA:

1.40 sq. ft.

FIXTURE WEIGHT:

Contact King Luminaire





Test Voltage: 120V
 Nominal Color Temperature: 3000 & 4000K¹
 4004 Engine Series: 4 COB Emitters (Type III)
 4006 Engine Series: 6 COB Emitters (Type V)
 LED Engine + Driver Rated Life = 100,000 hrs²

To learn more about the T1 Optic, please see the T1 Optic Information Sheet

Photometric Test Report Number	Decorative Option	Color Temperature	IES Distribution	Nominal Watts	Engine Series	Delivered Lumens ³	Efficacy (LM/W) ³	mA @ Emitter	Driver Output Current	BUG Rating	HID Equivalent ⁴
In Testing	N/A	3000	Type III	40	4004	N/A	N/A	265	265	N/A	50-70
0424NTIEA3X04040XXQ	N/A	4000	Type III	40	4004	5490	135	265	265	1-4-3	50-70
In Testing	N/A	3000	Type V	40	4006	N/A	N/A	175	350	N/A	50-70
0424NTIEA5X04040XXQ	N/A	4000	Type V	40	4006	5932	143	175	350	3-5-2	50-70
0424NTIEA3X06030XXP	N/A	3000	Type III	60	4004	7573	126.9	400	400	1-5-3	70-100
0424NTIEA3X06040XXQ	N/A	4000	Type III	60	4004	6942	114	400	400	1-4-5	70-100
In Testing	N/A	3000	Type V	60	4006	N/A	N/A	275	550	N/A	70-100
0424NTIEA5X06040XXX	N/A	4000	Type V	60	4006	7348	120.9	275	550	1-3-1	70-100
0424NTIEA3X07530XXP	N/A	3000	Type III	75	4004	9350	123.5	500	500	-	100-150
0424NTIEA3X07540XXS	N/A	4000	Type III	75	4004	7936	112.0	500	500	1-5-3	100-150
In Testing	N/A	3000	Type V	75	4006	N/A	N/A	340	680	N/A	100-150
In Testing	N/A	4000	Type V	75	4006	N/A	N/A	340	680	N/A	100-150
In Testing	N/A	3000	Type III	100	4004	N/A	N/A	620	620	N/A	150-250
0424NTIEA3X10040XXX	N/A	4000	Type III	100	4004	9065	93.6	620	620	1-5-3	150-250
In Testing	N/A	3000	Type V	100	4006	N/A	N/A	430	860	N/A	150-250
0424NTIEA5X10040XXQ	N/A	4000	Type V	100	4006	11736	118.9	430	860	4-0-5	150-250

Lens: Acrylic Refractor

¹Color temperature is nominal, please see test report for specific chromaticity information

²Contact factory for TM21 information

³Due to the continuous advancements in LED technology, luminaire delivered lumen and efficacy is subject to change without notice at the discretion of King Luminaire

⁴Equivalence should always be confirmed by performing a photometric layout, due to the variability of performance requirements and application criteria

FIXTURE OPTIONS

Capital Options

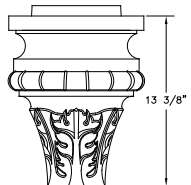

K13

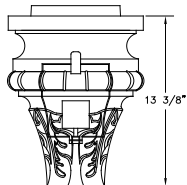

K14 C/W PR

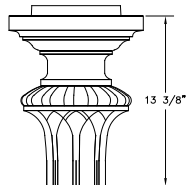

K16

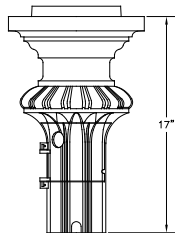

K18 C/W PR

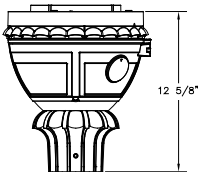

K26 C/W PR

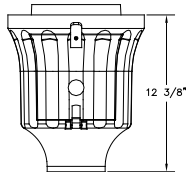

K24 C/W PR

Decorative Options

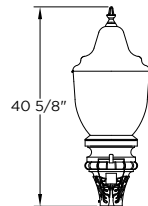

STANDARD

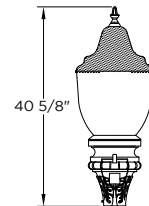

SOLID SPUN ALUMINUM TOP

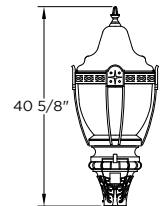

WESTINGHOUSE RING & STRUTS

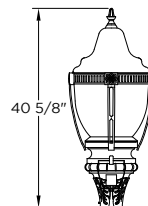

GENERAL ELECTRIC RING & STRUTS

Finial Options



#1



#2



#3

