

KA18 // THE BISHOPS CROOK ARM

DECORATIVE ARM

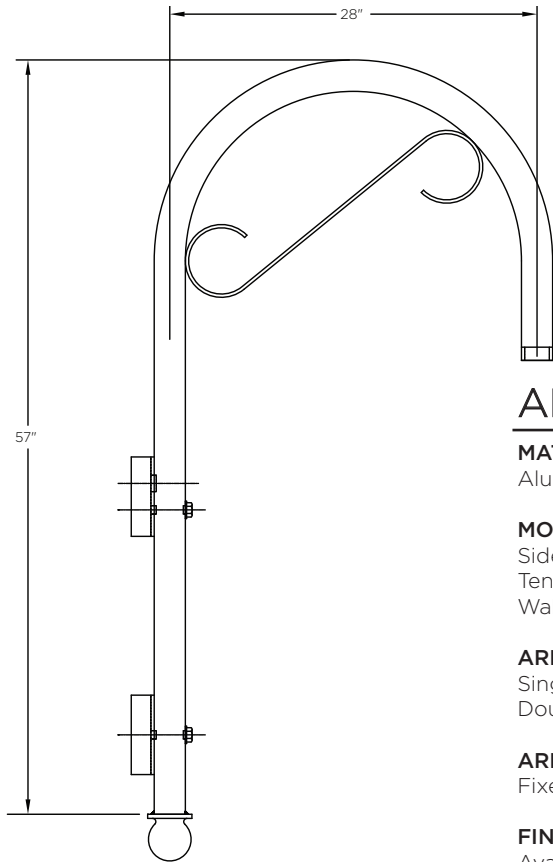

The King Luminaire KA18 Arm is a unique design with minimal scroll detail. This aluminum arm is available in single and double mounting arm configurations. The KA18 provides an easy and straightforward solution for any project.

ARM SPECIFICATIONS

MATERIAL:
Aluminum

MOUNTING TYPE:
Side
Tenon
Wall

ARM QUANTITY:
Single
Double

ARM LENGTH:
Fixed Length

FINISH:
Available in textured or smooth.

EPA
1.78 - 7.05 sq. ft.

WEIGHT
13 - 46 lbs

MOUNTING TYPES:

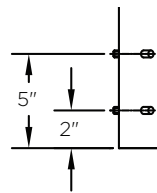

Tenon Mount Details
To Accept A 1 1/2" IPS (1.90" O.D.)
Tenon x 6" Long

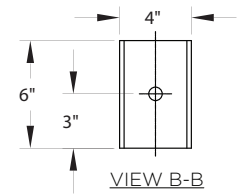
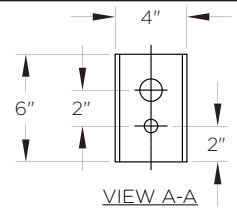

Side/Wall Mount Details

LEVELLING DEVICES:



KPL10



KPL11

*See leveling device spec sheet for more options

DECORATIVE DETAIL:

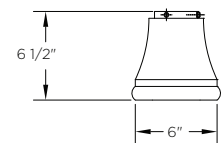

Tenon Decorative Shroud

HOW TO ORDER

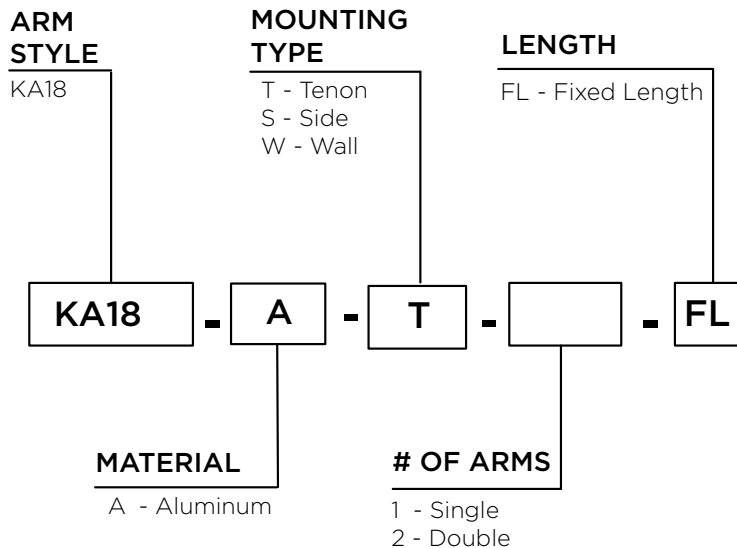

EPA & WEIGHT

Catalog Number	Mount Type	# of Arms	L. (in)	EPA (sq ft)	Wt. (lbs)
KA18-A-S-1-FL	Side	1	28	1.85	23
KA18-A-S-2-FL	Side	2	28	3.70	46
KA18-A-T-1-FL	Tenon	1	28	1.78	13
KA18-A-T-2-FL	Tenon	2	28	3.56	26
KA18-A-W-1-FL	Wall	1	28	1.85	23

CONFIGURATION OPTIONS

KA18 THE BISHOPS CROOK ARM

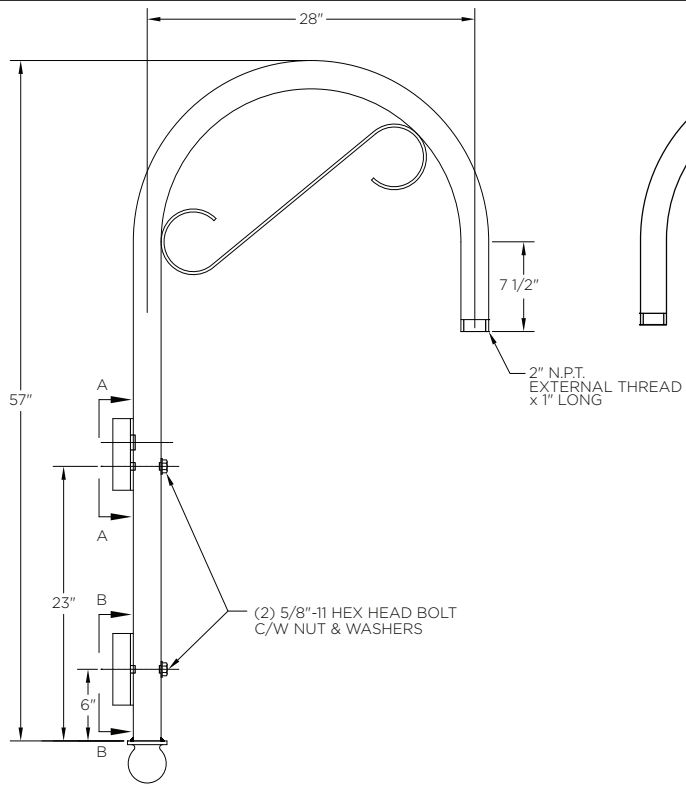

Side Mount Single Arm

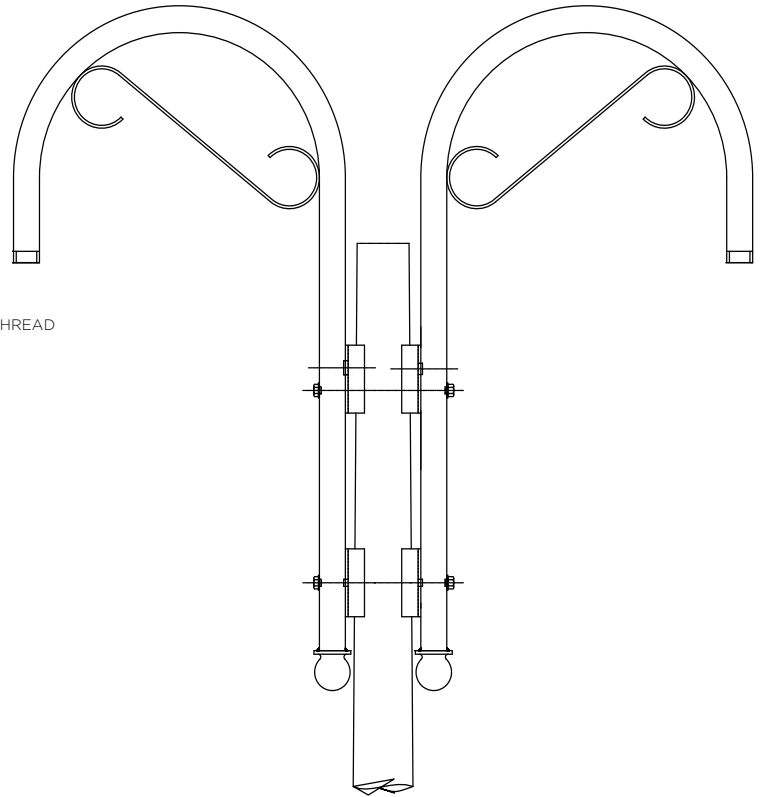

Side Mount Double Arm

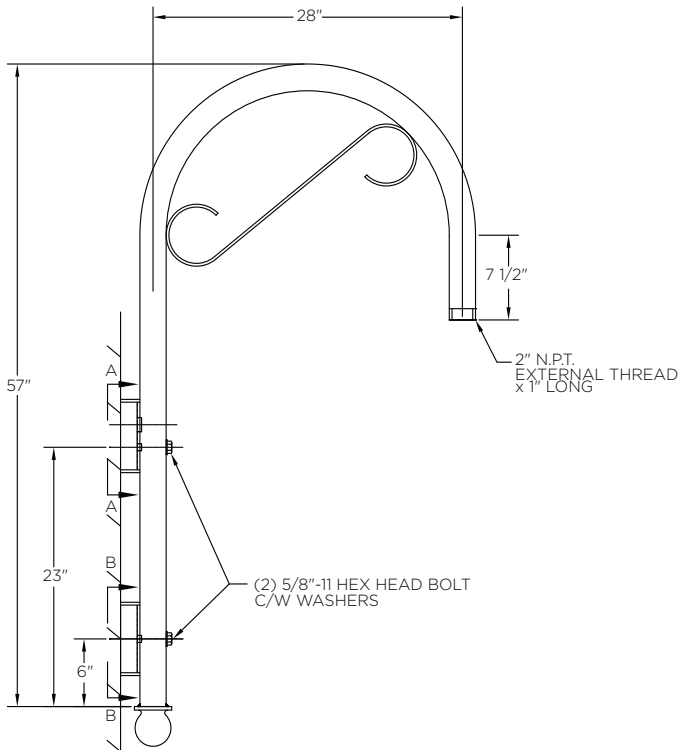

Wall Mount Single Arm

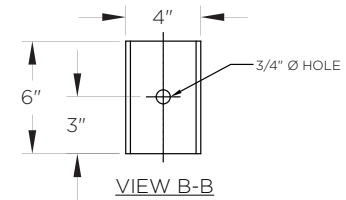
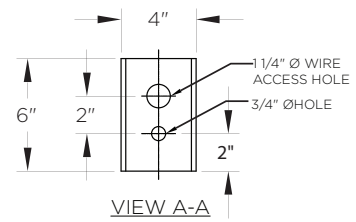

Side/Wall Mount Details

CONFIGURATION OPTIONS

KA18 THE BISHOPS CROOK ARM

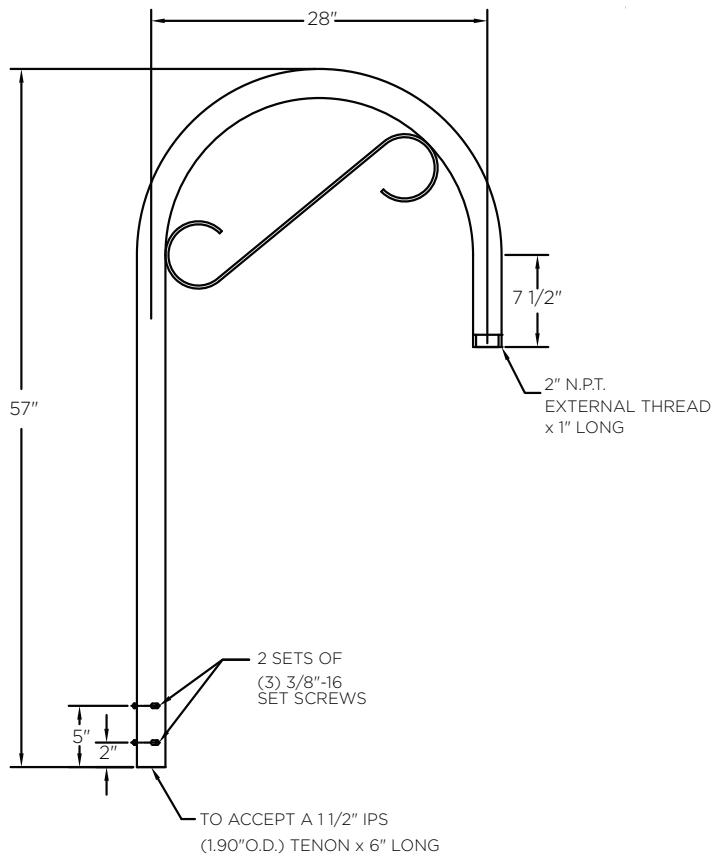

Tenon Mount Single Arm

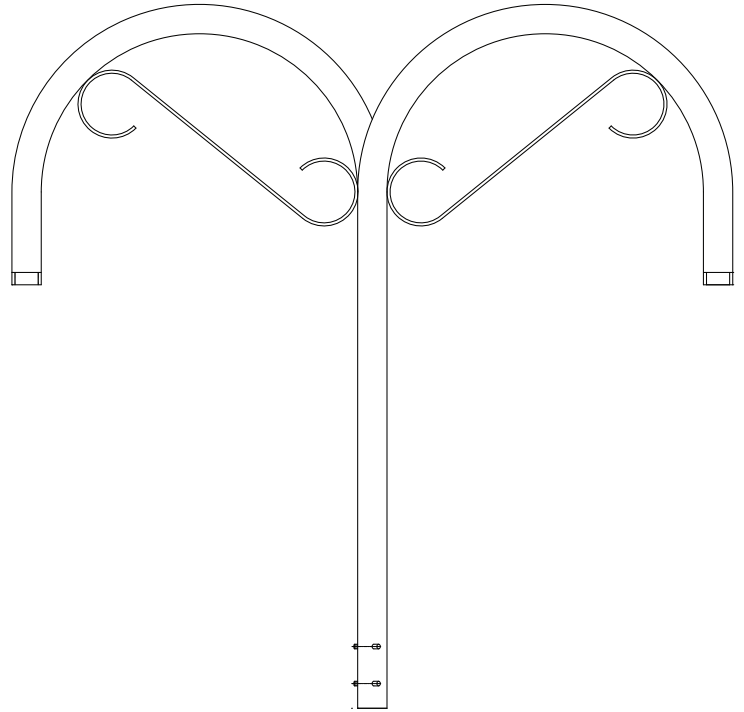

Tenon Mount Double Arm

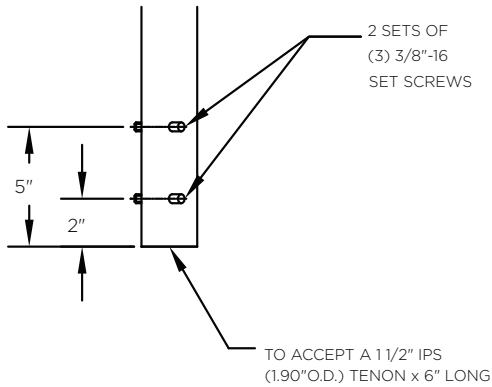

Tenon Mount Details